

Royde & Tucker H125-300 HI-LOAD Anti-ligature butt hinge

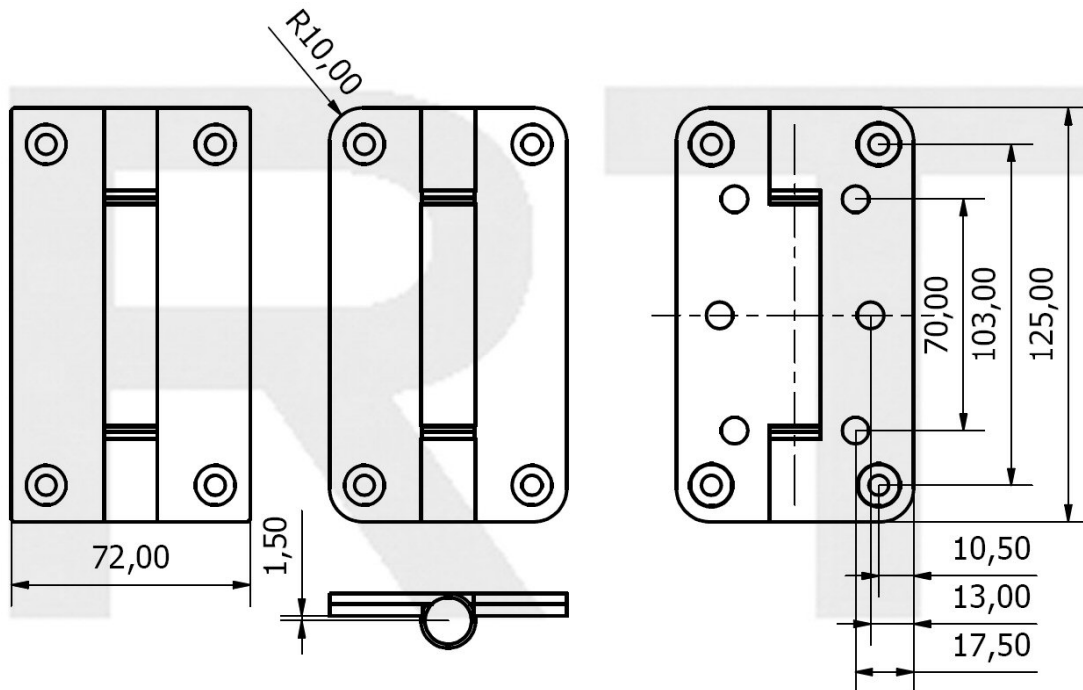

- 125x72x6.75mm Three knuckle butt hinge
- Tested to & passed the DHF TS 001: Door mounted anti-ligature devices. Certificate TC/07/09/01/C1 Grade 4
- Maximum adjusted door weight 160kg
- To BS EN 1935 Grade 12
- Minimum door thickness 44mm
- Maintenance free, guaranteed for 25 years
- CE Certificate No. 2812-CPR-AC0064
- Suitable for use on fire doors: Certifire approved – CF209
- To be fitted with HP125-300 intumescent hinge pads, if being installed on fire doors
- 4 x Security Resistorx screws to security faceplates
- 6 x metric 6 x 32mm wood screws
- Unless otherwise stated stainless steel substrate, Grade 316 stainless steel available

Note:

- Mortice detail "B" for installation

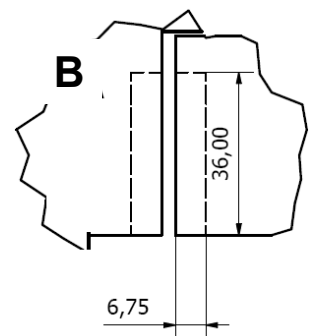

Royde & Tucker Ltd
Bilton Road
Cadwell lane
Hitchin
SG4 0SB
Tel:01462 444444
Fax:01462 444433
www.ratman.co.uk
e-mail: sales@ratman.co.uk