

Royde & Tucker HL2002 hush latch

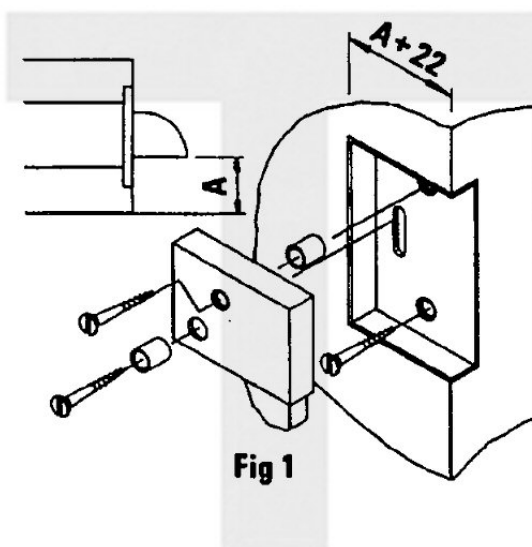
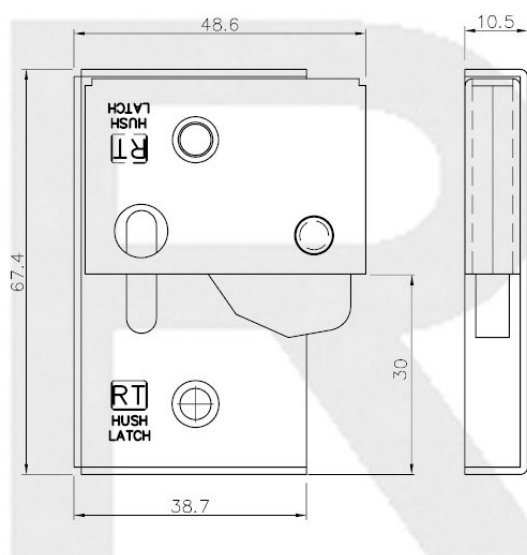

The hush latch is a modified striking plate, recessed into the door frame for use with a standard mortice latch or lock. It is designed to minimise the resistance standard latchbolts often encounter when they make contact with a traditional strikeplate.

This allows door closer power to be kept to a minimum and overcomes the difficulties and inconvenience that strongly sprung door closers present to children, the old, the infirm or those with a disability.

Fixing

- 1) To find the position of the mortice cut-out – mark the position of the top edge of the bevelled spring latch on the door frame.
- 2) Mark 35mm above and 32mm below this line
- 3) Establish dimension 'A' + 22mm from the face of the door frame
- 4) Cut the mortice 10mm deep
- 5) Fit the hush latch as illustrated inclusive of the 2 screw spacers, 1 from either side of the cam body.
- 6) Test closing and latching action of door and amend fitting if necessary
- 7) If required fit the mortice plate to accept the deadbolt

- Mild steel
- Cam block sintered iron
- Unit weight 0.08kg
- Packing box quantity 20 or 200