

EXTeRUS – Options

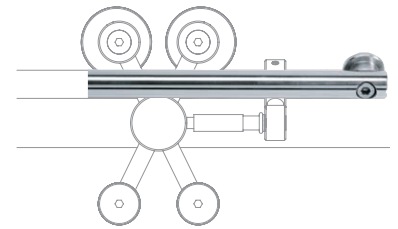

Track

EXTeRUS tracks are available in AISI 316 stainless steel or Satin Nickel finishes and 2, 3 and 4 metre lengths as standard, drilled for side mounted fixing. Standard spacing's are shown below. For special non-stocked track lengths and drilling placements please contact the sales office.

K7500 3

Track (2m length)

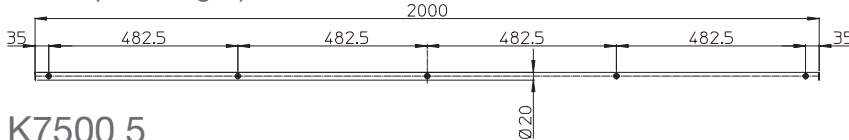

K7500 5

Track (3m length)

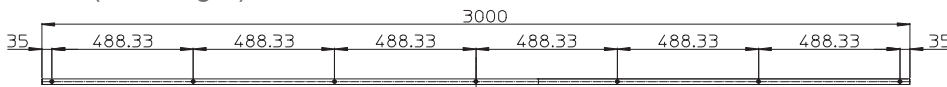

K7500 39

Track (4m length)

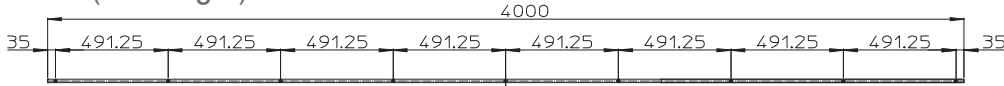

Fixing brackets & accessories

EXTeRUS can be mounted to solid block/brickwork walls, stud walls (subject to wall being able to support the adjusted weight of the door leaf) and glass walls, as in glass partitioning.

Brackets are supplied in pack quantities to suit the length of track and are inclusive of M8x60mm bolts (suitable for use with 1 additional 4mm spacer only). Optional M8 rawlshields are available to ensure a secure fix for solid walls. For stud/drylined walls M8 plated turboscrews are available in two lengths.

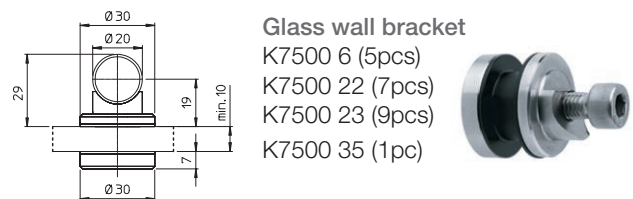
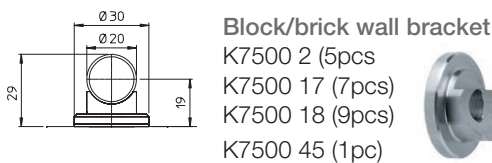

Optional fixings

K7500 00	M8 rawlshield for brick/block wall fixing
K7500 27	M8x70mm bolt
K7500 28	M8x80mm bolt
K7500 070	M8x70mm nickel plated turboscrew
K7500 100	M8x100mm nickel plated turboscrew

4mm track spacer plates

Where the door leaf is thick enough to risk engaging the wall onto which it's mounted 30x4mm spacers can be used to project the leaf away from the face of the wall. Several plates can be used although the length of any fixing has to be increased accordingly.

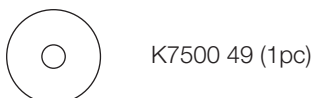

N.B. If ordering Satin Nickel please add NS to all part numbers.

EXTeRUS – Technical drawings

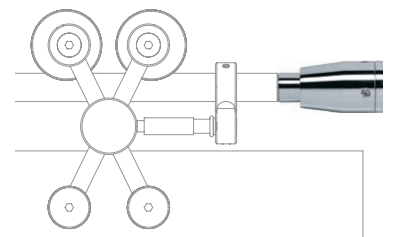

End mounting

EXTeRUS can be mounted within an opening using the optional end fixing brackets in conjunction with standard side mounting brackets.

K7500 48 EXTeRUS End mounting unit (1pc)

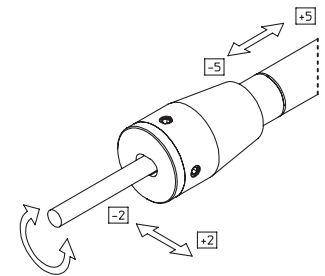
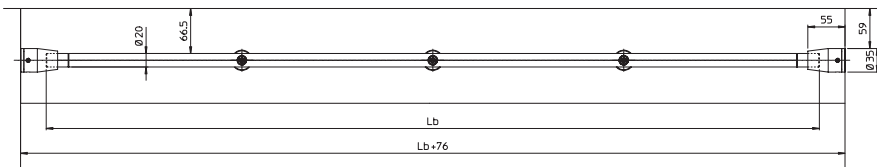

N.B. Track requires special preparation. Please contact the sales office for details.

Side mounts require special projection units. Please contact the sales office for details

Top mounting

EXTeRUS can be top hung from the ceiling where side fixing may be inappropriate. Top mounts can be used in conjunction with side/end mounts

K7500 47 EXTeRUS Top mounting unit (1pc)

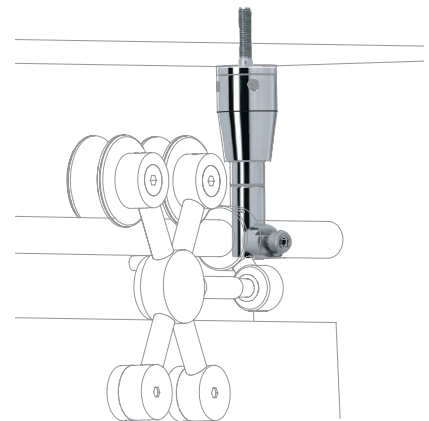

Lower glass door buffers

For use on pairs of frameless glass door leaves.

These buffers prevent the leading edge of the door coming into contact with its counterpart

K7500 32 EXTeRUS Lower stopper – glass (1pc)



Door bottom guides (details)

Wood K7500 13 (1pc)

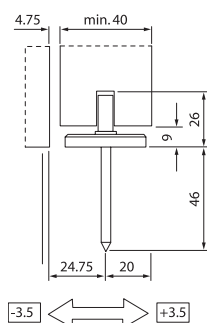

Glass (8–12mm) K7500 12 (1pc)

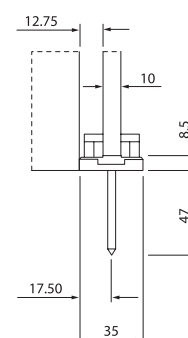

N.b. If ordering Satin Nickel please add NS to all part numbers.